

IMPROVE YOUR SETUP TIME!!

Innovative Exchangeable Head System

■ MillLine
TUNGMEISTER

■ DrillLine
DRILLMEISTER

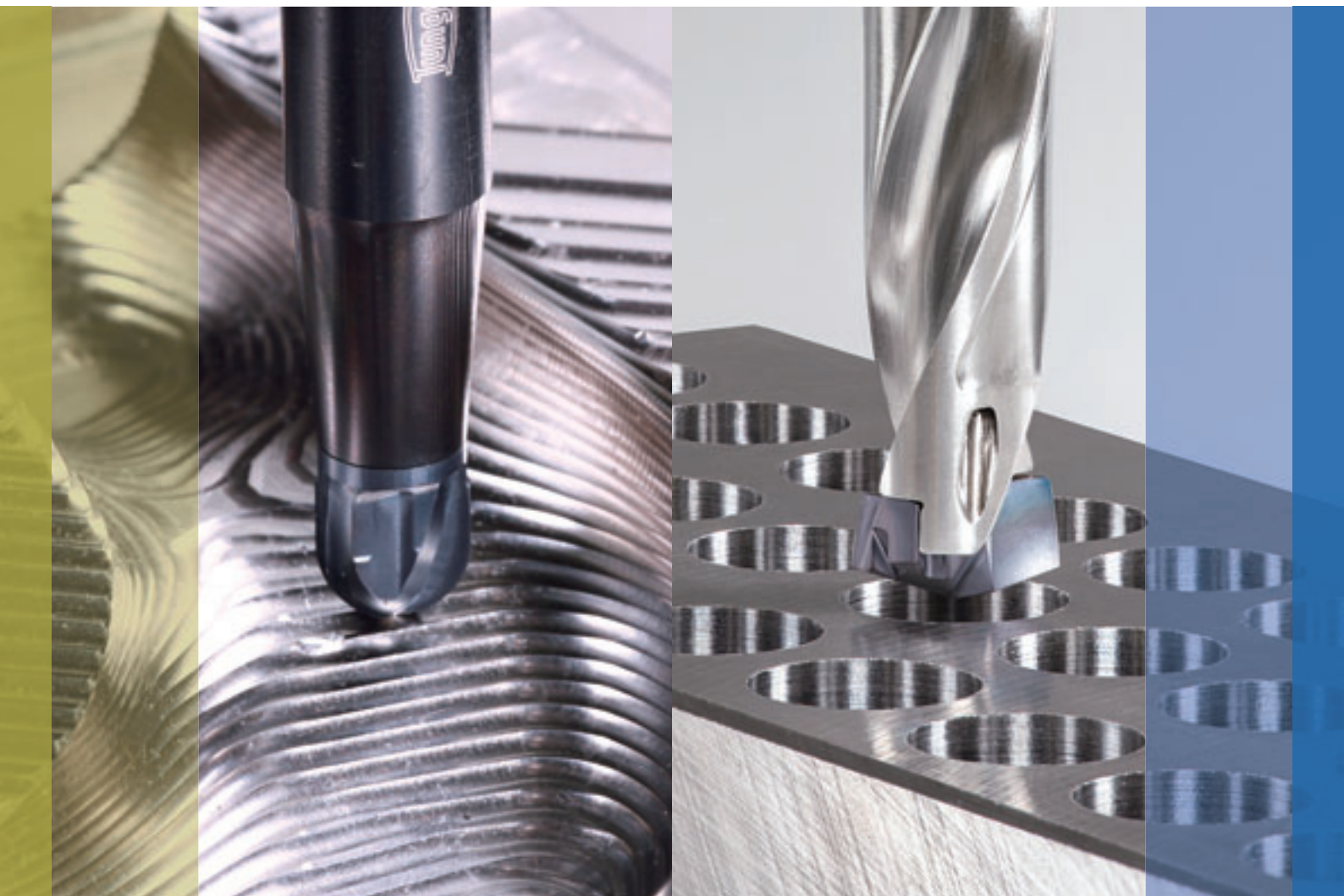

Quick Change Milling Head

Others **Vs** Tungaloy's System

Costly



Solid Carbide Endmill



Economical

Use a short carbide head as needed for the application

Replaceable Carbide Head



Inefficient



No Setup Time

Reduce machine downtime by replacing the head on the machine *with exchange accuracy within 0.02 mm*

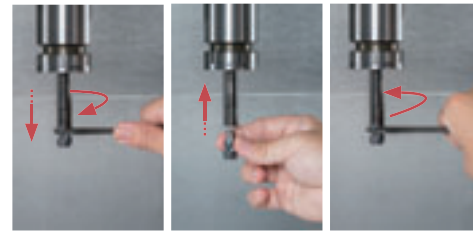

< 1 min

Versatile Hundreds of combinations available with wide range of heads in different shapes and sizes!



Combine drilling and chamfering operations, therefore reducing to one operation



Chamfering inserts

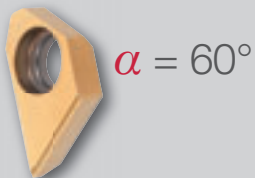
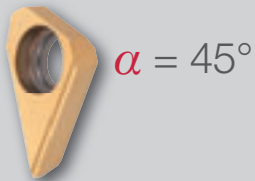
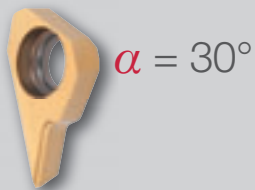

Drill body types

Flange type TID:

for general drilling operation

Straight type TIDC:

for pre-thread hole or with chamfer



Tool depth capacity

Available in:

1.5xD

3xD

5xD

8xD

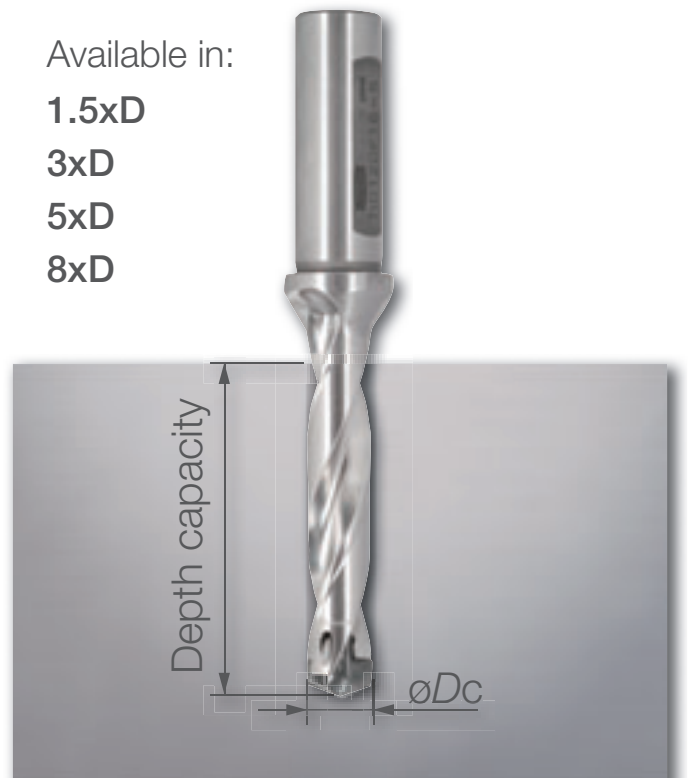

No setup time and machine downtime



Center drilling + chamfering

VDP head

2 flutes for center drilling + chamfering (DIN332)

- **Range:** from $\varnothing 3.28$ to $\varnothing 6.46$ mm with 60° chamfer

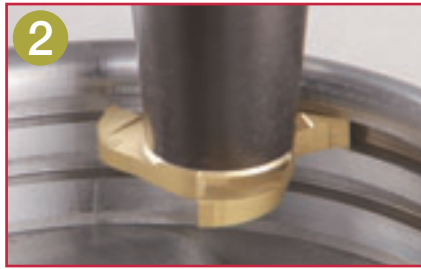

Shallow slotting

VST head

3, 4, 6 flutes for slot milling solution

- Form slotting operation
- Chamfering operation
- **Width range:** from 0.76 to 10 mm with slotting **depth** up to 6 mm



T-Slot milling

VTB head

6 flutes for high productivity

- Form slotting operation
- Slotting with corner radius and chamfer
- **Width range:** from 2 to 8 mm with slotting **depth** up to 5.9 mm

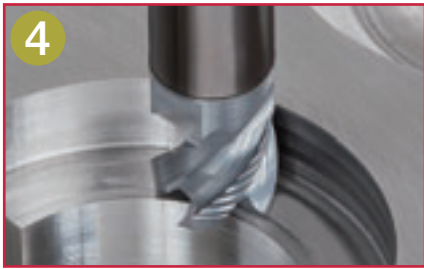

Roughing & finishing combination head

VEE-C head

4 flutes / 45° helix

- Reduces cutting load and vibration due to combined roughing and finishing flutes
- **Range:** from $\varnothing 8$ to $\varnothing 20$ mm with possibility to machine almost any material



Concave radius milling

VCR head

2 flutes with concave radius

- For edge breaking and deburring
- Useful for machining edges of pockets or holes for easy entry of male parts in an assembly
- **Range:** from $\varnothing 8$ to $\varnothing 20$ mm with concave radii of **R1** to **R6** mm



Quick Change Drilling Head

Tungaloy's System Vs **Others**

Economical

Use a short carbide head needed for the drilling operation



Costly

Expensive full carbide drill

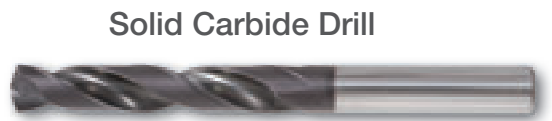

No Setup Time

Reduce machine downtime by replacing the head on the machine

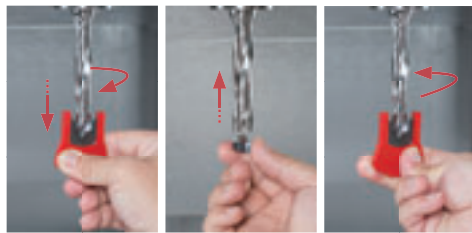

< 1 min

Inefficient



Versatile Tool range in increments of 1 mm covers from $\varnothing 10$ to $\varnothing 19.9$ mm; 10 different heads in 0.1 mm increments mount on each drill body

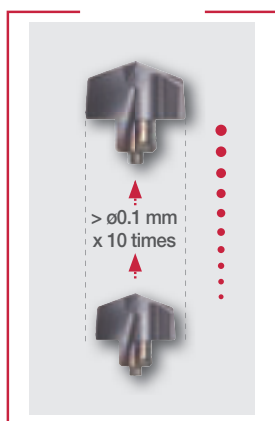

x 10 = Covers for hole diameter range from $\varnothing 10$ to $\varnothing 19.9$ mm

Tungaloy Corporation (Head office)

11-1 Yoshima-Kogyodanchi
Iwaki-city, Fukushima, 970-1144 Japan
Phone: +81-246-36-8501
Fax: +81-246-36-8542
www.tungaloy.co.jp

Tungaloy America, Inc.

3726 N Ventura Drive
Arlington Heights, IL 60004, U.S.A.
Phone: +1-888-554-8394
Fax: +1-888-554-8392
www.tungaloyamerica.com

Tungaloy Canada

432 Elgin St. Unit 3
Brantford, Ontario N3S 7P7, Canada
Phone: +1-519-758-5779
Fax: +1-519-758-5791
www.tungaloy.co.jp/ca

Tungaloy de Mexico S.A.

C Los Arellano 113,
Parque Industrial Siglo XXI
Aguascalientes, AGS, Mexico 20290
Phone: +52-449-929-5410
Fax: +52-449-929-5411
www.tungaloy.co.jp/mx

Tungaloy do Brasil Comércio de Ferramentas de Corte Ltda.

Rua dos Sabias N.104
13280-000 Vinhedo, São Paulo, Brazil
Phone: +55-19-38262757
Fax: +55-19-38262757
www.tungaloy.co.jp/br

Tungaloy Germany GmbH

An der Alten Ziegelei 1
D-40789 Monheim, Germany
Phone: +49-2173-90420-0
Fax: +49-2173-90420-19
www.tungaloy.de

Tungaloy France S.A.S.

ZA Courtaboef - Le Rio
1 rue de la Terre de feu
F-91952 Courtaboef Cedex, France
Phone: +33-1-6486-4300
Fax: +33-1-6907-7817
www.tungaloy.fr

Tungaloy Italia S.r.l.

Via E. Andolfato 10
I-20126 Milano, Italy
Phone: +39-02-252012-1
Fax: +39-02-252012-65
www.tungaloy.it

Tungaloy Czech s.r.o.

Turanka 115
CZ-627 00 Brno, Czech Republic
Phone: +420-532 123 391
Fax: +420-532 123 392
www.tungaloy.cz

Tungaloy Ibérica S.L.

C/Miquel Servet, 43B, Nau 7
Pol. Ind. Bufalvent
ES-08243 Manresa (BCN), Spain
Phone: +34 93 113 1360
Fax: +34 93 876 2798
www.tungaloy.es

Tungaloy Scandinavia AB

S:t Lars Väg 42A
SE-22270 Lund, Sweden
Phone: +46-462119200
Fax: +46-462119207
www.tungaloy.se

Tungaloy Rus, LLC

36-D Harkovsky Lane
308009 Belgorod, Russia
Phone: +7 4722 24 00 07
Fax: +7 4722 24 00 08
www.tungaloy.co.jp/ru

Tungaloy Polska Sp. z o.o.

ul. Genewska 24
03-963 Warszawa, Poland
Phone: +48-22-617-0890
Fax: +48-22-617-0890
www.tungaloy.co.jp/pl

Tungaloy U.K. Ltd

The Technology Centre,
Wolverhampton Science Park
Glaisher Drive, Wolverhampton
West Midlands WV10 9RU, UK
Phone: +44 121 309 0163
Fax: +44 121 270 9694
www.tungaloy.co.jp/uk
salesinfo@tungaloyuk.co.uk

Tungaloy Hungary Kft

Erzsébet királyné útja 125
H-1142 Budapest, Hungary
Phone: +36 1 781-6846
Fax: +36 1 781-6866
www.tungaloy.co.jp/hu
info@tungaloytools.hu

Tungaloy Turkey

Dudullu, OSB 4. Cad No:4
34776 Ümraniye Istanbul, TURKEY
Phone: +90 216 540 04 67
Fax: +90 216 540 04 87
www.tungaloy.com.tr
info@tungaloy.com.tr

Tungaloy Benelux b.v.

Tjalk 70
NL-2411 NZ Bodegraven, Netherlands
Phone: +31 172 630 420
Fax: +31 172 630 429
www.tungaloy-benelux.com

Tungaloy Croatia

Malinska 8
10430 Samobor, Croatia
Phone: +385 1 3326 604
Fax: +385 1 3327 683
www.tungaloy.hr

Tungaloy Cutting Tool (Shanghai) Co., Ltd.

Rm No 401 No.88 Zhabei
Jiangchang No.3 Rd
Shanghai 200436, China
Phone: +86-21-3632-1880
Fax: +86-21-3621-1918
www.tungaloy.co.jp/tcts

Tungaloy Cutting Tool (Thailand) Co., Ltd.

TCIF Tower 4th Fl.
1858/5-7 Bangna-Trad Road
km.5 Bangna, Bangna, Bangkok 10260
Thailand
Phone: +66-2-751-5711
Fax: +66-2-751-5715
www.tungaloy.co.th

Tungaloy Singapore (Pte.), Ltd.

62 Ubi Road 1, #06-11 Oxley BizHub 2
Singapore 408734
Phone: +65-6391-1833
Fax: +65-6299-4557
www.tungaloy.co.jp/tspl

Tungaloy India Pvt. Ltd.

Unit#13, B wing, 8th floor
Kamala Mills Compound
Trade World, Lower Parel (West)
Mumbai - 4000 13, India
Phone: +91-22-6124-8804
Fax: +91-22-6124-8899
www.tungaloy.co.jp/in

Tungaloy Korea Co., Ltd

#1312, Byucksan Digital Valley 5-cha
Beotkkot-ro 244, Geumcheon-gu
153-788 Seoul, Korea
Phone: +82-2-2621-6161
Fax: +82-2-6393-8952
www.tungaloy.co.jp/kr

Tungaloy Malaysia Sdn Bhd

50 K-2, Kelana Mall, Jalan SS6/14
Kelana Jaya, 47301
Petaling Jaya, Selangor Darul Ehsan
Malaysia
Phone: +603-7805-3222
Fax: +603-7804-8563
www.tungaloy.co.jp/my

Tungaloy Australia Pty Ltd

PO Box 2232, Rowville,
Victoria 3178, Australia
Phone: +61-3-9755-8147
Fax: +61-3-9755-6070
www.tungaloy.co.jp/au

PT. Tungaloy Indonesia

Kompleks Grand Wisata Block AA-10
No.3-5 Cibitung
Bekasi 17510, Indonesia
Phone: +62-21-8261-5808
Fax: +62-21-8261-5809
www.tungaloy.co.jp/id



www.tungaloy.com

follow us at:

facebook.com/tungaloyjapan

twitter.com/tungaloyjapan

To see this product in action visit:

Tung-TV

www.youtube.com/tungaloycorporation

Distributed by:



DOWNLOAD
Dr. Carbide App



Available on the
App Store



GET IT ON
Google play



ISO 9001 Certified
QC00J0056
Tungaloy Corporation
18/10/1996

ISO 14001 Certified
EC97J123
Tungaloy Group
Japan site and Asian
production site
26/11/1997